

NOK Standard Oil Seals

SC_{Type}, SB_{Type}

Nitrile rubber (NBR) oil seals

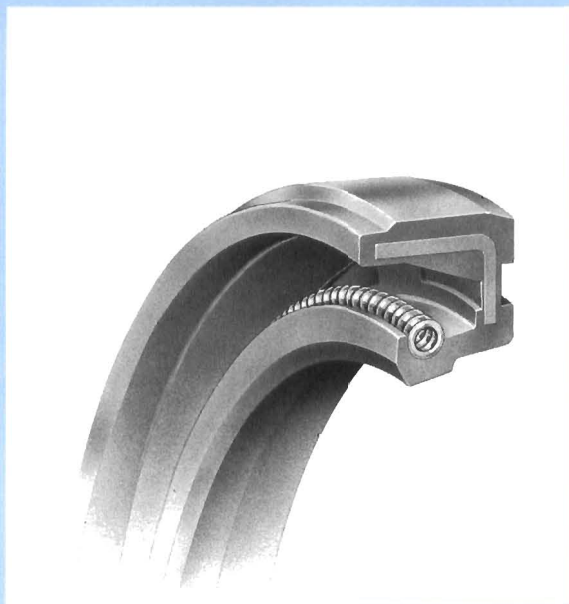

- When ordering, please indicate the NOK part number and the relevant dimensions.
- Check the Guide to Allowable Operating Conditions on pages E-6 and E-7 for relevant information on the seal selected before use.

Lip Material	NOK A727: Shaft diameter class 150 mm or smaller NOK A941: Shaft diameter class 150 mm or larger
--------------	---

SC Type, SB Type

Material Nitrile (NBR)

● The sectional view on the right shows the typical profile of the seal type.

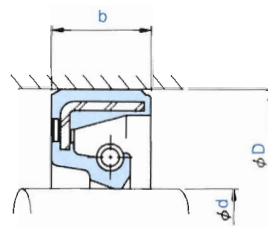

SC type

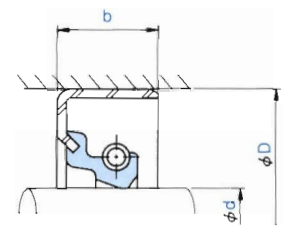

SB type

Dimensions			Part Number	Part Number
Shaft diameter d	Outside diameter D	Width b		
6	16	7	AC 0052 E3	—
7	18	7	AC 0087 E0	—
7	20	7	AC 0090 A0	AB 0090 E0
8	18	7	AC 0145 E0	AB 0145 E0
8	18	9	—	AB 0147 F0
8	22	7	AC 0158 A8	AB 0158 E0
9	22	7	AC 0205 A0	AB 0205 E0
10	20	7	AC 0260 H0	AB 0260 E0
10	21	8	AC 0267 E0	AB 0267 E0
10	22	8	AC 0271 E0	AB 0271 F0
10	25	7	AC 0279 A0	AB 0279 E0
10	26	8	AC 0283 E0	—
10	28	8	AC 0285 E0	—
10	30	7	AC 0288 E0	AB 0288 E0
11	22	7	AC 0308 E1	AB 0308 E2
11	25	7	AC 0311 E0	AB 0311 E1
11	30	7	AC 0314 E0	—
12	22	7	AC 0371 E0	AB 0371 E0
12	25	7	AC 0382 A0	AB 0382 E0
12	28	7	AC 0387 E0	AB 0387 E0
12	30	9	AC 0393 E0	AB 0393 E0
12	32	6	—	AB 0398 E0
13	25	7	AC 0473 F0	AB 0473 E1
13	28	7	AC 0478 A0	AB 0478 E0
13	30	8	AC 0483 E1	—
14	24	6	AC 0514 E0	AB 0514 E0
14	25	7	AC 0519 E0	AB 0519 E1
14	28	7	AC 0526 A0	AB 0526 E0
14	32	9	AC 0536 E0	—
15	24	7	AC 0584 E1	AB 0584 E0
15	25	7	AC 0588 E5	AB 0588 F0
15	28	7	AC 0592 E1	AB 0592 E0
15	30	7	AC 0598 A0	AB 0598 E0
15	32	7	AC 0603 E0	AB 0603 E0
15	32	9	AC 0604 E0	AB 0604 E0
15	34	10	AC 0606 E0	—
15	35	7	AC 0610 F3	AB 0610 E0
15	35	8	AC 0611 E0	—
15	37	7	AC 0616 E0	—
16	26	7	AC 0678 E0	AB 0678 E0

SC Type, SB Type

Material Nitrile (NBR)

● The sectional view on the right shows the typical profile of the seal type.

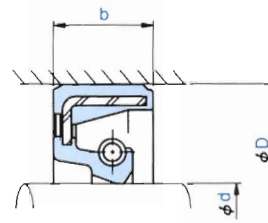

SC type

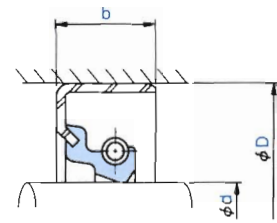

SB type

Dimensions			Part Number	Part Number
Shaft diameter d	Outside diameter D	Width b		
16	28	6	AC 0684 E1	—
16	28	7	AC 0685 F0	AB 0685 E0
16	30	7	AC 0687 A0	AB 0687 E0
16	32	8	AC 0691 E0	—
16	35	9	—	AB 0698 E0
17	28	7	—	AB 0736 F0
17	30	6	AC 0742 E0	AB 0742 G0
17	30	7	AC 0743 E0	—
17	30	8	AC 0745 E0	AB 0745 G0
17	32	7	AC 0750 E1	—
17	32	8	—	AB 0751 E0
17	35	6	AC 0758 E0	—
17	35	7	AC 0759 H0	AB 0759 E0
17	35	8	AC 0760 A0	—
17	38	7	AC 0768 E1	AB 0768 E0
17	40	8	AC 0771 F0	AB 0771 E1
17	40	10	AC 0773 E0	—
18	30	7	AC 0816 E0	AB 0816 E0
18	30	8	AC 0817 E0	AB 0817 E0
18	32	9	AC 0825 E0	—
18	35	7	AC 0828 E0	—
18	35	8	AC 0829 A0	AB 0829 E0
18	35	9	—	AB 0831 E0
18	38	7	AC 0838 E0	—
19	30	8	AC 0864 F0	AB 0864 E0
19	35	8	AC 0875 A0	—
19	38	7	—	AB 0880 E0
19	38	10	—	AB 0881 E0
19	40	10	AC 0883 E0	AB 0883 E0
20	30	7	AC 0984 E0	AB 0984 H0
20	30	9	AC 0987 E0	AB 0987 E0
20	32	8	AC 0997 E0	AB 0997 E0
20	34	7	AC 1003 E1	—
20	35	7	AC 1012 E0	AB 1012 E0
20	35	8	AC 1013 A0	AB 1013 E0
20	36	7	AC 1017 E0	AB 1017 F0
20	36	10	—	AB 1019 E0
20	40	7	AC 1029 E0	AB 1029 E0
20	40	8	AC 1030 E0	AB 1030 E3
20	40	10	AC 1032 F0	AB 1032 E0

SC Type, SB Type

Material Nitrile (NBR)

● The sectional view on the right shows the typical profile of the seal type.

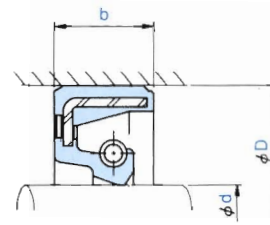

SC type

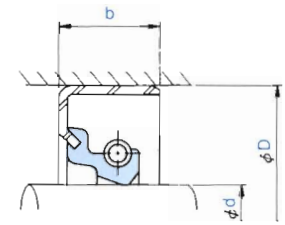

SB type

Dimensions			Part Number	Part Number
Shaft diameter d	Outside diameter D	Width b		
20	40	11	AC 1033 A0	AB 1033 F0
20	42	10	AC 1038 E0	AB 1038 E0
20	45	12	AC 1045 E0	AB 1045 E0
20	47	7	AC 1048 E0	—
21	35	7	AC 1084 E1	AB 1084 E0
22	32	7	AC 1116 E3	AB 1116 E0
22	35	7	AC 1126 F0	AB 1126 E0
22	35	8	AC 1127 E0	AB 1127 E0
22	36	10	AC 1130 E0	AB 1130 E0
22	37	8	AC 1131 E0	—
22	38	8	AC 1133 E0	AB 1133 E0
22	38	12	AC 1136 E0	—
22	40	8	AC 1138 E0	AB 1138 E1
22	40	10	AC 1140 E0	AB 1140 E0
22	42	7	AC 1145 E0	AB 1145 E0
22	42	10	AC 1147 E0	—
22	42	11	AC 1148 A0	AB 1148 E0
23	32	7	AC 1213 P1	—
23	42	7	—	AB 1223 E0
23	42	11	AC 1224 A0	AB 1224 E0
24	38	7	AC 1251 E0	—
24	38	8	AC 1252 E0	AB 1252 E0
24	38	10	—	AB 1255 E0
24	40	7	AC 1259 E0	—
24	40	8	AC 1260 A0	AB 1260 E0
24	45	7	—	AB 1265 E0
25	35	6	AC 1292 G0	—
25	37	8	AC 1302 F0	AB 1302 F0
25	38	7	AC 1306 E0	AB 1306 E0
25	38	8	—	AB 1307 E0
25	40	8	AC 1314 A0	AB 1314 F0
25	40	10	AC 1315 E0	AB 1315 E0
25	42	8	AC 1322 E0	AB 1322 E0
25	42	10	AC 1324 E0	—
25	42	11	AC 1325 E0	—
25	44	7	AC 1327 F0	—
25	45	7	AC 1334 E0	—
25	45	8	AC 1335 E0	AB 1335 F0
25	45	10	—	AB 1337 F0
25	45	11	AC 1338 A7	AB 1338 E0

SC Type, SB Type

Material Nitrile (NBR)

● The sectional view on the right shows the typical profile of the seal type.

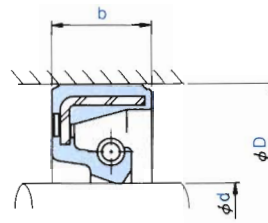

SC type

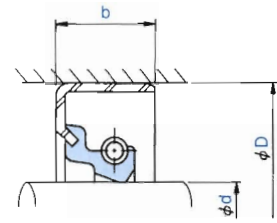

SB type

Shaft diameter d	Dimensions		Part Number	Part Number
	Outside diameter D	Width b		
25	47	6	AC 1348 E1	AB 1348 E0
25	47	7	AC 1350 E0	—
25	47	10	—	AB 1352 E0
25	48	8	AC 1357 E0	—
25	50	9	AC 1361 E0	AB 1361 E0
25	50	12	—	AB 1363 E0
25	52	8	AC 1374 E2	—
25	52	10	—	AB 1377 E0
25	52	12	—	AB 1379 E0
26	36	8	—	AB 1459 E0
26	38	8	AC 1464 E0	AB 1464 E0
26	40	8	AC 1468 E0	AB 1468 E0
26	42	8	AC 1474 A0	AB 1474 F0
27	40	8	—	AB 1508 E0
27	42	8	AC 1511 E0	—
27	43	9	AC 1512 E0	AB 1512 E0
27	47	11	AC 1518 A0	AB 1518 E0
28	38	7	AC 1531 F0	AB 1531 E0
28	38	8	—	AB 1532 E1
28	40	8	AC 1538 F0	AB 1538 E0
28	42	8	AC 1544 E0	AB 1544 E0
28	44	8	AC 1545 E0	—
28	44	11	AC 1546 E0	AB 1546 G1
28	45	8	AC 1550 E0	AB 1550 E0
28	48	11	AC 1563 A0	AB 1563 E0
28	50	8	AC 1569 E0	—
28	50	10	AC 1570 E0	—
30	39	7	—	AB 1651 F0
30	40	7	—	AB 1656 E0
30	42	8	AC 1666 E2	AB 1666 E0
30	44	9	AC 1673 E0	AB 1673 E0
30	45	7	AC 1677 E1	—
30	45	8	AC 1679 A0	AB 1679 G0
30	45	9	—	AB 1680 E0
30	45	11	AC 1681 E0	—
30	45	12	AC 1682 E0	AB 1682 E0
30	46	9	AC 1689 E0	AB 1689 E0
30	47	8	AC 1692 E0	AB 1692 F0
30	47	10	—	AB 1693 E0
30	47	12	—	AB 1695 E0

SC Type, SB Type

Material Nitrile (NBR)

● The sectional view on the right shows the typical profile of the seal type.

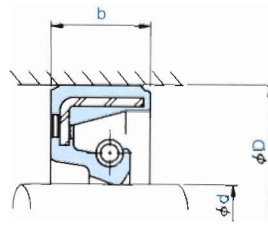

SC type

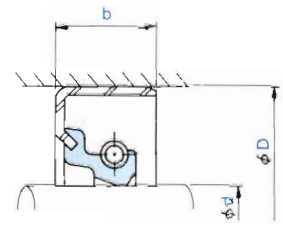

SB type

Shaft diameter d	Dimensions		Part Number	Part Number
	Outside diameter D	Width b		
30	48	8	AC 1700 E0	AB 1700 E0
30	48	11	AC 1702 E0	AB 1702 E0
30	50	7	AC 1704 E0	AB 1704 F0
30	50	8	—	AB 1705 F0
30	50	9	AC 1706 E0	AB 1706 E0
30	50	10	AC 1708 E0	AB 1708 E0
30	50	11	AC 1709 A0	AB 1709 G0
30	52	7	AC 1719 E0	—
30	52	10	AC 1721 E0	AB 1721 E0
30	55	12	—	AB 1736 E0
31	47	7	AC 1797 E1	—
31	50	8	AC 1799 E0	—
32	43	10	—	AB 1869 E0
32	44	9	AC 1871 G1	AB 1871 E0
32	45	8	AC 1880 E0	AB 1880 E0
32	46	8	AC 1884 E0	AB 1884 E0
32	47	8	—	AB 1888 F0
32	48	7	AC 1893 E0	—
32	48	8	—	AB 1894 E0
32	51	10	AC 1898 E0	—
32	52	8	AC 1902 E0	AB 1902 E0
32	52	11	AC 1904 A0	AB 1904 E0
33	50	7	AC 1933 E0	AB 1933 E0
33	50	8	AC 1934 E0	—
33	52	7	AC 1937 E0	AB 1937 E0
33	56	12	AC 1939 E0	—
34	48	8	AC 1968 G1	AB 1968 E0
34	50	7	AC 1971 E0	—
34	54	11	AC 1978 A0	AB 1978 E0
35	47	7	AC 2041 E0	AB 2041 F0
35	48	8	AC 2048 E0	AB 2048 E0
35	50	7	AC 2056 E0	AB 2056 E0
35	50	8	AC 2057 A0	AB 2057 G0
35	50	10	—	AB 2059 E0
35	50	11	AC 2060 E0	—
35	52	7	AC 2066 E0	AB 2066 E0
35	52	8	AC 2067 E0	—
35	52	9	AC 2068 E0	—
35	52	10	AC 2069 E0	AB 2069 E0
35	52	12	—	AB 2072 F0

SC Type, SB Type

Material Nitrile (NBR)

● The sectional view on the right shows the typical profile of the seal type.

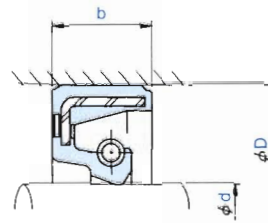

SC type

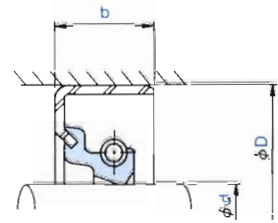

SB type

Shaft diameter d	Dimensions		Part Number	Part Number
	Outside diameter D	Width b		
35	55	8	AC 2081 E0	AB 2081 E0
35	55	9	—	AB 2083 F0
35	55	11	AC 2085 A0	AB 2085 F0
35	56	10	AC 2094 E0	—
35	58	9	AC 2099 E0	AB 2099 E1
35	60	8	AC 2103 E1	—
35	60	12	AC 2107 E0	AB 2107 F0
35	62	10	AC 2118 E0	AB 2118 E0
35	62	12	AC 2121 E0	—
36	50	7	AC 2162 E0	AB 2162 E0
36	50	10	—	AB 2164 E0
36	54	8	AC 2166 E0	—
37	62	12	AC 2204 E0	—
38	47	10	—	AB 7101 E0
38	50	8	AC 2218 E0	AB 2218 E1
38	55	8	AC 2230 E0	AB 2230 E0
38	55	9	AC 2231 E0	AB 2231 E0
38	56	10	AC 2233 E1	—
38	58	7	—	AB 2238 E0
38	58	8	AC 2239 E0	AB 2239 E2
38	58	11	AC 2240 A7	AB 2240 G0
38	62	11	AC 2250 E0	AB 2250 E0
40	52	8	AC 2343 E4	AB 2343 E3
40	55	7	AC 2358 E1	—
40	55	8	AC 2359 E0	—
40	55	9	AC 2361 E0	AB 2361 G0
40	55	10	AC 2362 E0	—
40	56	8	AC 2365 E0	—
40	58	7	AC 2368 E0	—
40	58	8	AC 2369 A0	AB 2369 F0
40	60	8	AC 2375 E0	AB 2375 E0
40	60	10	AC 2377 E0	AB 2377 E0
40	60	12	—	AB 2379 F0
40	62	7	AC 2385 E0	AB 2385 E0
40	62	8	AC 2386 E0	AB 2386 E0
40	62	11	AC 2388 A0	AB 2388 F0
40	62	12	AC 2390 E0	AB 2390 H0
40	65	10	AC 2402 E0	AB 2402 E0
40	65	12	AC 2403 E0	AB 2403 E0
40	65	14	AC 2405 E0	—

SC Type, SB Type

Material Nitrile (NBR)

● The sectional view on the right shows the typical profile of the seal type.

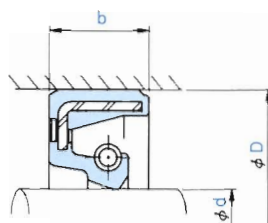

SC type

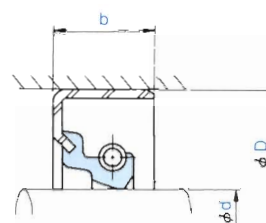

SB type

Dimensions			Part Number	Part Number
Shaft diameter d	Outside diameter D	Width b		
42	55	9	—	AB 2483 E0
42	58	10	AC 2491 E0	—
42	60	9	AC 2493 E0	AB 2493 F0
42	60	12	—	AB 2495 E0
42	62	10	AC 2499 E0	—
42	65	9	AC 2504 E0	AB 2504 E0
42	65	12	AC 2507 A0	AB 2507 E0
43	52	10	—	BB 2041 E0
43	60	10	AC 2539 E0	—
44	56	7	—	AB 2551 E0
45	60	7	—	AB 2641 E0
45	60	9	AC 2643 E0	AB 2643 F0
45	61	9	—	AB 2647 G0
45	62	9	AC 2651 A8	AB 2651 F0
45	62	10	AC 2652 E0	AB 2652 E0
45	62	12	AC 2653 E0	AB 2653 E0
45	65	10	AC 2658 E0	AB 2658 E0
45	65	12	AC 2659 E0	—
45	68	9	AC 2666 E0	AB 2666 F0
45	68	10	AC 2667 E0	—
45	68	12	AC 2668 A0	AB 2668 F0
45	70	12	AC 2676 E0	—
45	70	14	AC 2677 E0	AB 2677 E0
45	72	10	AC 2684 E0	—
45	72	12	AC 2685 E0	AB 2685 E0
46	65	9	AC 2717 E0	—
47	70	12	AC 2735 E0	AB 2735 E0
48	62	9	—	AB 2775 E0
48	65	9	AC 2780 E0	AB 2780 G0
48	68	10	AC 2785 E0	—
48	70	9	AC 2788 E0	AB 2788 E0
48	70	12	AC 2791 A0	AB 2791 E0
50	64	10	—	AB 2834 E0
50	65	9	AC 2838 G2	AB 2838 E0
50	68	9	AC 2847 E0	AB 2847 G0
50	68	10	AC 2848 E0	—
50	70	10	AC 2854 E0	AB 2854 G0
50	70	12	AC 2857 E0	AB 2857 E0
50	72	9	AC 2861 E0	AB 2861 E0
50	72	10	—	AB 2862 E0



SC Type, SB Type

Material Nitrile (NBR)

● The sectional view on the right shows the typical profile of the seal type.

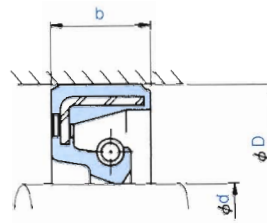

SC type

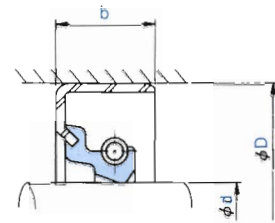

SB type

Dimensions			Part Number	Part Number
Shaft diameter d	Outside diameter D	Width b		
50	72	12	AC 2864 K0	AB 2864 G0
50	72	13	AC 2865 E0	—
50	74	12	AC 2872 E0	AB 2872 E0
50	80	10	—	AB 2886 E0
50	80	12	AC 2887 E0	AB 2887 F0
50	80	14	AC 2888 E0	AB 2888 E0
51	62	7	—	AB 8924 E1
52	70	9	AC 2959 E0	AB 2959 F0
52	72	10	AC 2961 E0	—
52	75	9	AC 2965 E0	AB 2965 E0
52	75	12	AC 2967 A5	AB 2967 E0
54	72	12	AC 3014 E0	AB 3014 E1
54	82	10	AC 3021 E1	—
55	70	9	AC 3036 E0	AB 3036 F0
55	72	9	AC 3040 A0	AB 3040 G0
55	78	9	AC 3053 E1	AB 3053 E0
55	78	12	AC 3055 A0	AB 3055 J0
55	80	12	AC 3062 E0	AB 3062 E0
55	85	14	AC 3072 E0	AB 3072 F0
56	78	12	AC 3094 E0	AB 3094 E0
57	78	10	AC 3107 E1	—
58	75	9	AC 3148 E0	AB 3148 E0
58	80	9	AC 3152 E0	AB 3152 G0
58	80	12	AC 3154 A9	AB 3154 E0
60	75	9	AC 3193 E2	AB 3193 F0
60	75	10	—	AB 3195 F0
60	78	9	AC 3204 E0	AB 3204 F0
60	80	10	AC 3211 E0	AB 3211 E0
60	80	12	AC 3213 E0	AB 3213 E0
60	82	9	AC 3220 E0	AB 3220 E0
60	82	12	AC 3222 A0	AB 3222 G0
60	85	12	AC 3234 E0	AB 3234 E0
60	90	14	—	AB 3244 E0
62	80	9	AC 3290 E0	AB 3290 F0
62	85	9	AC 3295 E0	—
62	85	12	AC 3297 A0	AB 3297 E0
63	80	9	AC 3316 E0	AB 3316 E0
63	85	9	—	AB 3320 E0
63	85	12	AC 3321 E0	AB 3321 E1
65	82	10	AC 3389 E0	AB 3389 E0

SC Type, SB Type

Material Nitrile (NBR)

● The sectional view on the right shows the typical profile of the seal type.

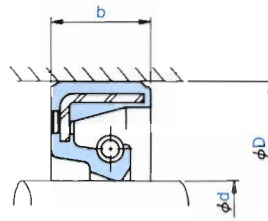

SC type

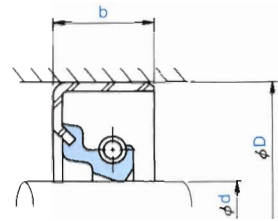

SB type

Shaft diameter d	Dimensions		Part Number	Part Number
	Outside diameter D	Width b		
65	82	12	AC 3390 E0	—
65	85	10	AC 3394 E1	—
65	85	12	AC 3395 E0	AB 3395 E0
65	88	12	AC 3400 A0	AB 3400 F0
65	90	10	AC 3406 E0	AB 3406 E0
65	90	12	AC 3408 E0	—
65	90	13	AC 3409 A0	AB 3409 F0
65	95	12	AC 3413 E0	—
65	95	14	AC 3414 F0	AB 3414 E0
66	86	10	AC 3427 E0	—
67	90	10	AC 3451 E0	—
68	90	12	AC 3459 A4	AB 3459 F0
68	95	13	AC 3463 E0	AB 3463 E0
70	88	12	AC 3505 E0	AB 3505 E0
70	90	10	—	AB 3512 E0
70	90	12	AC 3513 E1	AB 3513 E0
70	92	12	AC 3519 A0	AB 3519 G0
70	95	13	AC 3527 A0	AB 3527 G0
70	100	10	—	AB 3530 E0
70	100	14	AC 3532 E0	AB 3532 G0
71	95	13	AC 3549 E1	AB 3549 E0
72	100	12	AC 3562 E0	AB 3562 G0
75	100	13	AC 3618 E0	AB 3618 H0
75	105	12	AC 3628 E0	AB 3628 E0
75	105	15	AC 3631 E0	AB 3631 E0
80	100	9	AC 3731 E0	—
80	100	10	AC 3732 E1	AB 3732 E0
80	100	13	—	AB 3734 E0
80	105	13	AC 3744 A0	AB 3744 H0
80	115	15	AC 3761 E0	AB 3761 F0
82	105	13	AC 3786 E0	AB 3786 E0
85	105	15	—	AB 3837 E0
85	110	13	AC 3842 G0	AB 3842 H0
85	120	15	AC 3855 E0	AB 3855 E0
88	115	13	AC 3879 E0	AB 3879 E0
90	110	13	—	AB 3921 E0
90	115	13	AC 3932 A0	AB 3932 H0
90	115	15	—	AB 3934 E0
90	120	13	AC 3938 E0	AB 3938 E0
90	125	15	AC 3944 E0	AB 3944 E0

SC Type, SB Type

H

Material Nitrile (NBR)

● The sectional view on the right shows the typical profile of the seal type.

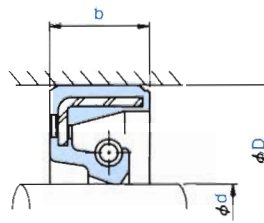

SC type

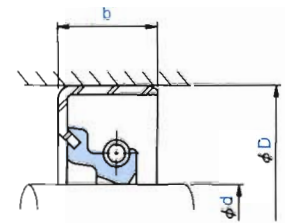

SB type

Shaft diameter d	Dimensions		Part Number	Part Number
	Outside diameter D	Width b		
90	130	13	—	AB 3948 E0
95	115	13	—	AB 3984 E0
95	120	13	AC 3994 E0	AB 3994 F0
95	125	14	—	AB 4000 E0
95	130	15	AC 4007 E0	AB 4007 E0
98	120	15	—	AB 4033 E0
100	120	12	—	AB 4055 E0
100	120	13	—	AB 4056 E0
100	125	13	AC 4063 G2	AB 4063 A0
100	125	15	—	AB 4065 E0
100	130	13	—	AB 4073 E1
100	130	15	—	AB 4074 E0
105	125	15	—	AB 4146 E0
105	130	13	—	AB 4150 E0
105	135	14	AC 4153 F0	AB 4153 E0
105	140	15	—	AB 4161 E0
110	140	14	AC 4212 E0	AB 4212 E0
110	140	15	—	AB 4213 E0
110	145	14	—	AB 4220 E0
110	145	15	—	AB 4221 E0
112	145	14	—	AB 4237 F0
115	145	14	AC 4282 F0	AB 4282 A0
115	150	16	—	AB 4292 E0
120	140	13	—	AB 4330 E1
120	150	14	AC 4346 F0	AB 4346 A0
120	155	16	AC 4355 E0	AB 4355 E0
125	155	14	AC 4399 E1	AB 4399 A0
125	160	16	AC 4404 E0	AB 4404 E0
128	153	18	—	AB 4433 E0
130	160	14	AC 4451 F2	AB 4451 A0
130	160	15	—	AB 4452 E0
130	160	16	—	AB 4453 E0
130	170	15	—	AB 4464 E0
130	170	16	AC 4465 E0	AB 4465 E0
135	165	14	AC 4498 E0	AB 4498 E0
135	170	15	—	AB 4503 E0
140	170	14	AC 4542 E0	AB 4542 A0
140	185	16	AC 4558 E0	AB 4558 E0
145	175	14	AC 4581 E0	AB 4581 A0
145	190	16	AC 4588 E0	AB 4588 E0

SC Type, SB Type

Material Nitrile (NBR)

● The sectional view on the right shows the typical profile of the seal type.

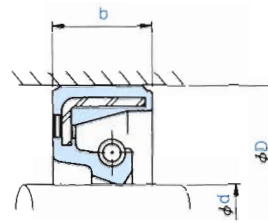

SC type

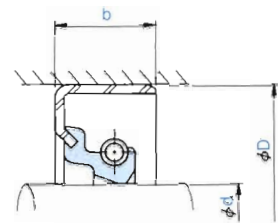

SB type

Shaft diameter d	Dimensions		Part Number	Part Number
	Outside diameter D	Width b		
150	180	14	AC 4624 E1	AB 4624 A0
150	195	20	—	AB 4635 E0
155	180	15	—	AB 4666 E0
155	185	15	—	AB 4669 E0
155	190	14	AC 4672 E0	—
155	200	20	—	AB 4678 E1
160	190	14	—	AB 4711 E0
160	190	15	AC 4712 E0	AB 4712 E0
160	190	16	AC 4713 E3	AB 4713 A0
160	195	18	AC 4717 E2	—
160	200	14	—	AB 4719 E0
160	200	20	—	AB 4721 E0
160	210	20	AC 4724 E3	AB 4724 E0
165	220	20	—	AB 4753 E0
170	200	16	—	AB 4795 A0
170	210	15	AC 4804 E0	—
170	225	20	AC 4815 E0	AB 4815 E0
175	230	20	—	AB 4855 E0
180	210	15	AC 4897 F0	—
180	210	16	AC 4898 E0	AB 4898 A0
180	215	16	—	AB 4904 E0
180	220	15	—	AB 4908 E1
180	220	20	AC 4911 E1	—
180	225	20	—	AB 4913 E0
180	235	20	—	AB 4915 E2
190	220	14	—	AB 4974 F0
190	220	15	AC 4975 E4	AB 4975 E0
190	225	15	AC 4982 E0	—
190	225	16	—	AB 4983 E0
190	245	22	AC 4993 E0	AB 4993 E0
200	230	14	AC 5052 E0	—
200	230	15	AC 5053 E1	AB 5053 P2
200	230	16	AC 5054 E0	AB 5054 G0
200	230	18	—	AB 5056 E0
200	235	16	—	AB 5060 E6
200	240	16	—	AB 5065 E0
200	240	20	AC 5068 E4	AB 5068 A0
200	242	20	AC 5070 E1	—
200	250	16	AC 5075 E0	—
200	255	22	—	AB 5079 E0



SC Type, SB Type

H

Material Nitrile (NBR)

●The sectional view on the right shows the typical profile of the seal type.

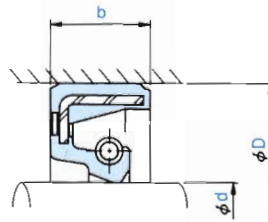

SC type

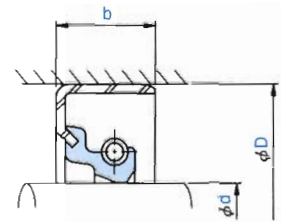

SB type

Dimensions			Part Number	Part Number
Shaft diameter d	Outside diameter D	Width b		
205	260	23	—	AB 5113 E0
210	240	15	AC 5133 E0	AB 5133 E0
210	250	16	—	AB 5138 E0
210	250	18	—	AB 5139 E0
210	250	20	AC 5140 E0	AB 5140 A0
210	265	23	—	AB 5146 E0
210	265	25	AC 5147 E1	—
220	250	15	AC 5204 E6	AB 5204 E0
220	255	16	AC 5207 E0	AB 5207 E0
220	259	22	AC 5210 E0	—
220	260	22	—	AB 5216 A0
220	275	23	AC 5224 E0	AB 5224 E0
230	260	15	AC 5281 E0	—
230	260	20	—	AB 5283 A0
230	285	23	AC 5296 E0	AB 5296 E0
240	270	15	AC 5339 E0	—
240	275	16	AC 5346 E2	—
240	280	19	—	AB 5351 A0
250	280	15	AC 5398 E1	AB 5398 E7
250	310	25	AC 5412 E5	AB 5412 A0
260	300	20	AC 5461 E6	—
260	320	25	—	AB 5471 A0
270	330	25	—	AB 5523 A0
280	316	18	AC 5558 E1	—
280	320	18	—	AB 5560 E0
280	330	24	AC 5568 E0	—
280	340	28	—	AB 5572 A0
290	330	18	—	AB 5586 E0
290	350	25	—	AB 5597 A0
300	345	22	—	AB 5631 E0
300	360	25	—	AB 5640 A0

NOK Standard Oil Seals

SC Type, SB Type

Acrylic rubber (ACM) oil seal



- When ordering, please indicate the NOK part number and the relevant dimensions.
- Check the Guide to Allowable Operating Conditions on pages E-6 and E-7 for relevant information on the seal selected before use.

Lip Material	NOK T303
--------------	----------

SC Type, SB Type

Material Acrylic (ACM)

●The sectional view on the right shows the typical profile of the seal type.

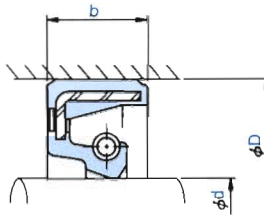

SC type

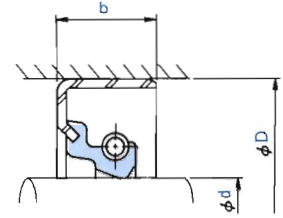

SB type

Dimensions			Part Number	Part Number
Shaft diameter d	Outside diameter D	Width b		
10	22	7	AC 0270 E1	—
10	25	7	AC 0279 A1	—
12	25	7	AC 0382 A1	—
15	30	7	AC 0598 G0	—
16	30	7	AC 0687 F1	—
17	30	8	AC 0745 G0	—
18	30	8	AC 0817 G0	—
20	35	8	AC 1013 A1	—
22	42	10	—	AB 1147 F0
25	40	8	AC 1314 A1	—
25	45	10	—	AB 1337 G0
28	40	8	AC 1538 H0	—
28	48	11	AC 1563 A1	—
30	45	8	AC 1679 A1	AB 1679 F0
30	50	11	AC 1709 A1	—
32	52	11	AC 1904 A1	—
35	50	8	AC 2057 A1	—
35	55	11	AC 2085 A1	—
38	58	11	AC 2240 A1	AB 2240 F0
40	58	8	AC 2369 E0	AB 2369 G0
42	60	9	—	AB 2493 E0
45	61	9	—	AB 2647 F0
45	62	9	AC 2651 A1	—
45	68	12	AC 2668 A1	AB 2668 G0
48	70	12	—	AB 2791 F0
50	72	12	AC 2864 A1	AB 2864 H0
55	78	12	AC 3055 A1	AB 3055 G0
58	80	12	—	AB 3154 F0
60	78	9	—	AB 3204 G0
60	82	12	AC 3222 A1	AB 3222 H0
62	85	12	AC 3297 A1	—
65	88	12	—	AB 3400 E1
65	90	13	—	AB 3409 H0
68	90	12	—	AB 3459 G0
70	92	12	—	AB 3519 F1
70	95	13	AC 3527 A1	—
75	95	10	AC 3609 F0	—
75	100	13	AC 3618 A1	AB 3618 A4
80	100	10	AC 3732 G0	—
80	105	13	AC 3744 A1	AB 3744 A4

SC Type, SB Type

Material Acrylic (ACM)

● The sectional view on the right shows the typical profile of the seal type.

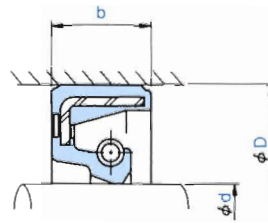

SC type

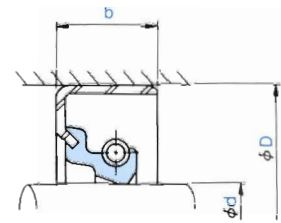

SB type

Shaft diameter d	Dimensions		Part Number	Part Number
	Outside diameter D	Width b		
80	115	15	—	AB 3761 E0
85	110	13	AC 3842 A1	—
90	115	13	AC 3932 A1	AB 3932 I0
95	120	13	AC 3994 A1	AB 3994 J0
95	130	15	—	AB 4007 F0
100	125	13	—	AB 4063 F0
105	135	14	—	AB 4153 G0
110	140	14	—	AB 4212 F0
110	145	15	—	AB 4221 G0
115	145	14	—	AB 4282 A1
120	150	14	—	AB 4346 A5
130	160	14	—	AB 4451 F0
140	170	14	—	AB 4542 E3
145	175	14	—	AB 4581 A5
150	180	14	AC 4624 F1	AB 4624 F0
160	190	16	—	AB 4713 E0
240	300	25	AC 5361 E3	—
250	285	16	AC 5403 E0	—
250	290	16	AC 5405 E0	—

NOK Standard Oil Seals

SC_{Type}, **SB**_{Type}

Silicone rubber (VMQ) oil seal



- When ordering, please indicate the NOK part number and the relevant dimensions.
- Check the Guide to Allowable Operating Conditions on pages E-6 and E-7 for relevant information on the seal selected before use.

Lip Material	NOK S728
--------------	----------

SC Type, SB Type

Material Silicone (VMQ)

● The sectional view on the right shows the typical profile of the seal type.

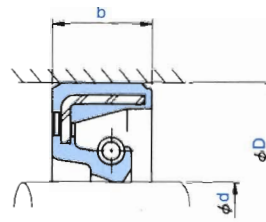

SC type

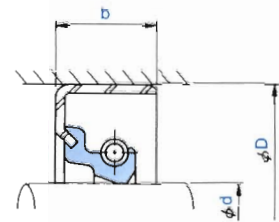

SB type

Dimensions			Part Number	Part Number
Shaft diameter d	Outside diameter D	Width b		
8	22	7	AC 0158 A9	—
10	25	7	AC 0279 A6	—
12	25	7	AC 0382 A6	—
14	28	7	AC 0526 E1	—
15	30	7	AC 0598 A5	—
15	35	7	AC 0610 E2	—
16	30	7	AC 0687 A2	—
17	35	8	AC 0760 A2	—
18	35	8	AC 0829 A4	—
20	35	7	AC 1012 G1	—
20	35	8	AC 1013 A2	—
20	36	7	AC 1017 F0	—
22	38	8	—	AB 1133 F0
25	40	8	AC 1314 A2	AB 1314 H0
25	45	11	AC 1338 A2	AB 1338 G2
26	42	8	AC 1474 A2	—
27	47	11	AC 1518 A2	—
30	45	8	AC 1679 A5	AB 1679 E1
30	50	8	—	AB 1705 E0
30	50	11	AC 1709 A2	—
30	52	12	AC 1724 E1	—
32	52	11	AC 1904 A4	—
35	50	7	—	AB 2056 I0
35	50	8	AC 2057 A7	—
35	55	9	—	AB 2083 E0
35	55	11	—	AB 2085 H0
38	55	8	—	AB 2230 F0
38	58	11	AC 2240 A2	—
40	58	8	AC 2369 A9	—
40	62	11	AC 2388 A2	—
40	62	12	AC 2390 F0	AB 2390 G2
42	65	12	AC 2507 E0	AB 2507 H1
45	61	9	—	AB 2647 E0
45	62	9	AC 2651 A2	AB 2651 H0
45	68	12	—	AB 2668 K3
48	70	12	AC 2791 A2	AB 2791 F1
50	68	9	AC 2847 A2	AB 2847 F2
50	70	10	—	AB 2854 E0
50	72	12	AC 2864 A2	—
55	72	9	AC 3040 A7	AB 3040 F0

SC Type, SB Type

H

Material Silicone (VMQ)

● The sectional view on the right shows the typical profile of the seal type.

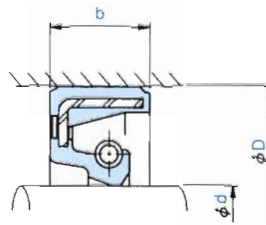

SC type

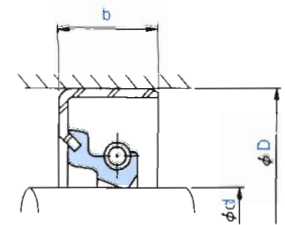

SB type

Dimensions			Part Number	Part Number
Shaft diameter d	Outside diameter D	Width b		
55	78	12	AC 3055 F0	—
58	80	9	—	AB 3152 E0
60	78	9	—	AB 3204 E3
60	80	10	AC 3211 F1	—
60	82	12	AC 3222 A2	AB 3222 I3
60	90	14	—	AB 3244 F1
62	85	12	AC 3297 A4	—
65	88	12	AC 3400 A2	AB 3400 E0
65	90	13	AC 3409 A2	AB 3409 E0
68	95	13	—	AB 3463 F1
70	92	12	AC 3519 A2	AB 3519 F2
70	95	13	—	AB 3527 F2
70	100	14	—	AB 3532 E0
72	100	12	—	AB 3562 E0
75	100	13	AC 3618 A4	AB 3618 A7
80	105	13	AC 3744 A2	AB 3744 F2
85	110	13	AC 3842 A2	—
90	115	13	AC 3932 F1	AB 3932 G8
90	125	15	—	AB 3944 F0
95	120	13	AC 3994 A2	AB 3994 G2
100	125	13	AC 4063 F1	AB 4063 E0
105	135	14	—	AB 4153 F3
110	140	14	—	AB 4212 G0
110	145	15	—	AB 4221 F0
115	145	14	AC 4282 E2	AB 4282 E1
120	150	14	—	AB 4346 A2
125	155	14	—	AB 4399 E0
130	160	14	—	AB 4451 E0
135	165	14	—	AB 4498 F1
140	170	14	—	AB 4542 E1
145	175	14	—	AB 4581 A2
150	180	14	AC 4624 F2	AB 4624 E0
160	190	16	—	AB 4713 H2
180	210	16	—	AB 4898 E2

NOK Standard Oil Seals

SC_{Type}, SB_{Type}

Fluorocarbon rubber (FKM) oil seal



- When ordering, please indicate the NOK part number and the relevant dimensions.
- Check the Guide to Allowable Operating Conditions on pages E-6 and E-7 for relevant information on the seal selected before use.

Lip Material	NOK F585
--------------	----------

SC Type, SB Type

Material Fluorocarbon (FKM)

● The sectional view on the right shows the typical profile of the seal type.

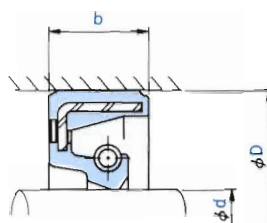

SC type

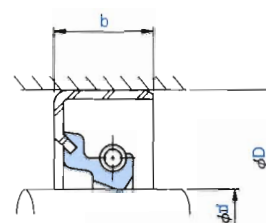

SB type

Shaft diameter d	Dimensions		Part Number	Part Number
	Outside diameter D	Width b		
7	20	7	AC 0090 E3	—
8	22	7	AC 0158 F2	AB 0158 A3
10	25	7	—	AB 0279 A3
12	22	7	AC 0371 G1	—
12	25	7	—	AB 0382 A5
12	32	7	AC 0399 E1	—
13	30	9	AC 0484 F2	—
15	30	7	AC 0598 E0	AB 0598 A4
15	35	7	AC 0610 E3	—
16	30	7	—	AB 0687 A4
17	30	7	AC 0743 F0	—
17	30	8	AC 0745 F2	—
17	35	8	—	AB 0760 A3
18	30	8	AC 0817 F1	—
18	35	8	—	AB 0829 A3
19	35	8	AC 0875 F0	AB 0875 A4
20	35	8	AC 1013 E1	AB 1013 A3
20	40	8	AC 1030 F0	—
20	40	11	AC 1033 E4	AB 1033 A3
22	42	10	AC 1147 F0	—
24	40	8	—	AB 1260 A4
25	40	8	AC 1314 F0	AB 1314 A3
25	45	11	AC 1338 G1	AB 1338 A3
28	48	11	—	AB 1563 A3
30	45	8	—	AB 1679 A3
30	45	9	AC 1680 E1	—
30	45	12	AC 1682 F1	—
30	50	11	AC 1709 E3	AB 1709 A3
32	45	8	AC 1880 H1	—
32	52	11	AC 1904 E4	AB 1904 G1
35	50	8	AC 2057 E4	AB 2057 A7
35	52	10	AC 2069 F0	—
35	55	8	AC 2081 G0	—
35	55	11	AC 2085 E2	AB 2085 A3
38	58	11	AC 2240 E2	AB 2240 A3
40	58	8	—	AB 2369 A3
40	60	12	AC 2379 F1	—
40	62	11	—	AB 2388 A3
40	62	12	AC 2390 G6	—
42	65	12	—	AB 2507 A6

SC Type, SB Type

Material Fluorocarbon (FKM)

●The sectional view on the right shows the typical profile of the seal type.

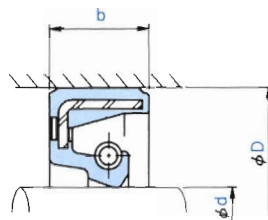

SC type

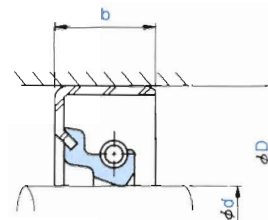

SB type

Shaft diameter d	Dimensions		Part Number	Part Number
	Outside diameter D	Width b		
45	62	9	—	AB 2651 A3
45	68	12	AC 2668 E1	AB 2668 A5
48	70	12	AC 2791 E0	AB 2791 A3
50	68	9	AC 2847 F3	AB 2847 A3
50	72	12	AC 2864 G5	AB 2864 A3
52	75	12	—	AB 2967 A3
55	72	9	—	AB 3040 A3
55	78	12	AC 3055 H2	AB 3055 A6
58	80	9	—	AB 3152 F0
58	80	12	AC 3154 A7	AB 3154 A5
60	78	9	AC 3204 F2	—
60	80	10	AC 3211 G1	—
60	82	12	AC 3222 E8	AB 3222 A3
60	90	13	AC 3243 E1	—
62	85	12	—	AB 3297 A3
65	88	12	—	AB 3400 A3
65	90	13	AC 3409 G2	AB 3409 G1
65	95	14	AC 3414 E0	—
68	90	12	—	AB 3459 A3
70	92	12	AC 3519 G6	AB 3519 A3
70	95	13	—	AB 3527 A3
72	100	12	—	AB 3562 F0
75	100	13	AC 3618 F5	AB 3618 A3
80	105	13	AC 3744 I2	AB 3744 A3
85	110	13	AC 3842 F1	AB 3842 A3
90	115	13	AC 3932 E5	AB 3932 A5
95	120	13	AC 3994 A5	AB 3994 A3
100	125	13	AC 4063 H0	AB 4063 E1
105	135	14	AC 4153 E6	AB 4153 A3
110	140	14	AC 4212 F6	AB 4212 A3
115	145	14	—	AB 4282 A3
120	150	14	AC 4346 E0	AB 4346 A3
125	155	14	—	AB 4399 A3
130	160	14	—	AB 4451 A3
135	165	14	AC 4498 F4	AB 4498 A3
140	170	14	—	AB 4542 A3
145	175	14	AC 4581 G1	AB 4581 A3
150	180	14	AC 4624 G1	AB 4624 A3
160	190	16	—	AB 4713 F0
160	200	15	AC 4720 E1	—

